

OMRON

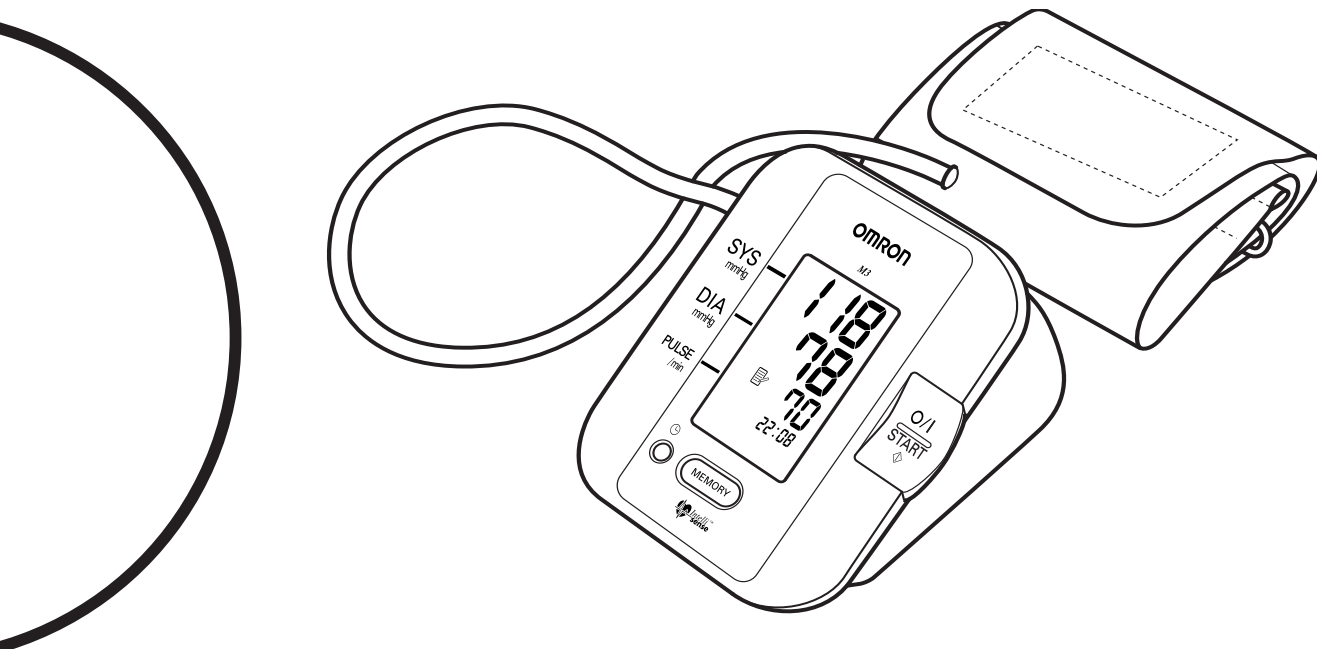

Digital Automatic Blood Pressure Monitor Model M3 Intellisense

- **Instruction Manual**
- **Mode d'emploi**
- **Gebrauchsanweisung**
- **Manuale di istruzioni**
- **Manual de instrucciones**
- **Gebruiksaanwijzing**
- **РУКОВОДСТВО ПО ЭКСПЛУАТАЦИИ**

EN

FR

DE

IT

ES

NL

RU



A Good Sense of Health

IM-HEM-7051-E-02-08/08
1647554-2B

Contents

Contents	2
Introduction	3
Important Safety Information	4
1. Overview	5
2. Preparation	8
2.1 Installing/Replacing the Batteries.....	8
2.2 Setting the Date and Time	10
2.3 Adjusting the Settings Modes	13
3. Using the Unit	14
3.1 How to Sit Correctly When Taking a Measurement	14
3.2 Applying the Arm Cuff	16
3.3 Taking a Reading	18
3.4 Instructions for special conditions	22
3.5 Using the Memory Function	23
4. Quick Reference Guide	26
5. Handling Errors and Problems	27
5.1 Error Messages.....	27
5.2 Troubleshooting	29
6. Maintenance and Storage	31
7. Optional Parts	34
8. Technical Data	35
9. Some Useful Information about Blood Pressure	37

Introduction

Thank you for purchasing the OMRON M3 Intellisense Upper Arm Blood Pressure Monitor.

The OMRON M3 Intellisense is a fully automatic blood pressure monitor, operating on the oscillometric principle. It measures your blood pressure and pulse rate simply and quickly. For comfortable controlled inflation without the need for pressure pre-setting or re-inflation the device uses its advanced “IntelliSense” technology.

The unit also stores up to 42 measurements in memory and calculates an average reading based on the three most recent measurements taken within 10 minutes of the last reading. (If there are only two readings in memory for that period, the average will be based on two readings. If there is only one reading in memory for that period, that reading will be displayed as the average value.)

Please read this instruction manual thoroughly before using the unit. For specific information about your own blood pressure, CONSULT YOUR DOCTOR.

Important Safety Information

Consult your doctor during pregnancy, arrhythmia and arteriosclerosis.

You should never change the dosage of medication prescribed by your doctor.

Use the M3 Intellisense only for yourself.

Caution:

- Do not leave the unit unattended with infants or persons who cannot express their consent.
- Do not use the unit for any purpose other than measuring blood pressure.
- Do not use a cellular phone near the unit. This may result in incorrect operation of the unit.
- Do not operate unit in a moving vehicle (car, airplane).
- Do not apply strong shocks and vibrations to or drop the main unit and arm cuff.
- Please observe the following points.
 - Do not insert the batteries with their polarities incorrectly aligned.
 - Replace old batteries with new ones immediately.
 - When you are not going to use the unit for a long period of time (approximately three months or more), take out the batteries.
 - Do not use new and used batteries together.
 - Do not use batteries of a different type together.
 - Only use four “AA” manganese or alkaline batteries with this unit. Do not use other types of batteries.
 - When using batteries, the battery liquid may leak and damage the main unit.
- Do not forcibly bend the arm cuff or bend the air tube excessively.
- When removing the air tube, pull on the air plug at the connection with the main unit not the tube itself.
- Do not inflate the arm cuff when it is not wrapped around your arm.

1. Overview

Main unit

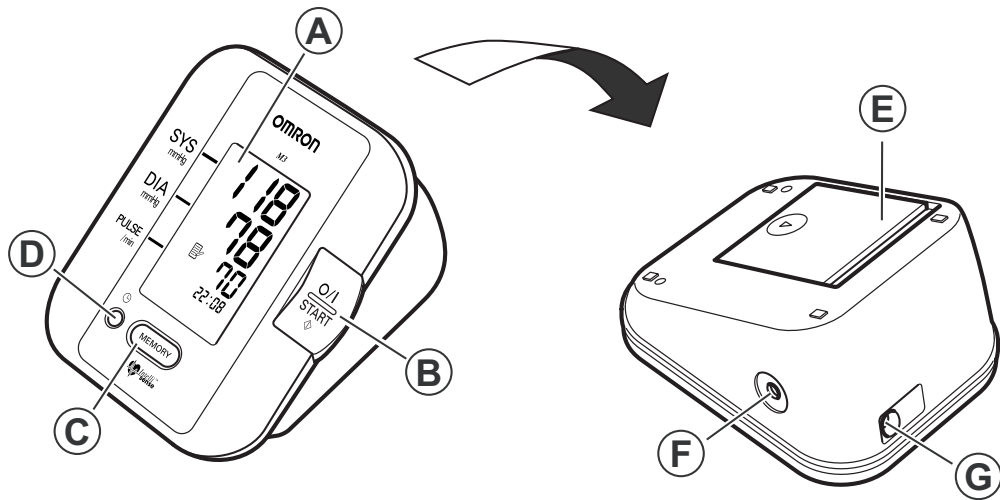

- A. Display
- B. O/I START button
- C. MEMORY button
- D. SET button

- E. Battery compartment
- F. Air jack
- G. AC adapter jack (for optional AC adapter)

Arm Cuff

If air starts to leak from the arm cuff, please replace with a new one. (Refer to Chapter 7 “Optional Parts”.)

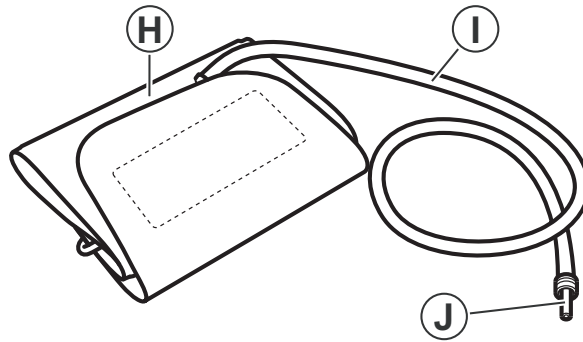

- H. Arm cuff
(Medium cuff: arm circumference 22-32 cm)
- I. Air Tube
- J. Air Plug

Display

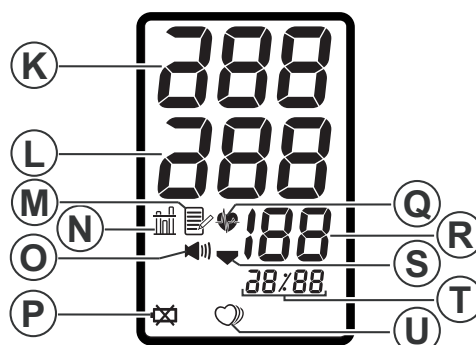

- | | |
|--|---|
| K. Systolic blood pressure | Q. Heartbeat symbol |
| L. Diastolic blood pressure | 1. (Flashes during measurement) |
| M. Memory symbol | 2. (If flashing after measurement complete indicates blood pressure out of recommended range) |
| (Displayed when viewing values stored in memory) | R. Pulse display |
| N. Average value symbol | S. Deflation symbol |
| (Displayed when viewing value for the last three measurements) | T. Date/Time display |
| O. Buzzer symbol | U. Irregular heartbeat symbol |
| P. Battery low symbol | |

Package contents

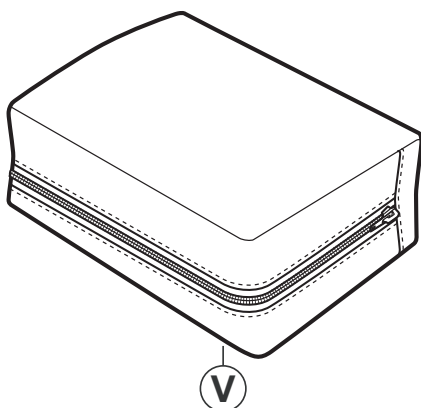

- V. Storage case
W. Four "AA" alkaline (LR6) batteries

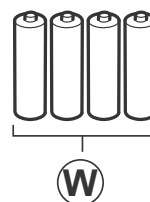

- Instruction manual
- Guarantee card
- Blood pressure pass
- Blood Pressure Monitor unit

2. Preparation

2.1 Installing/Replacing the Batteries

1. Turn the main unit upside down.
2. Slide the battery cover in the direction of the arrow while pressing the ribbed part of the cover.
3. Install or replace four “AA” size batteries so that the + (positive) and - (negative) polarities match the polarities indicated on the battery compartment.
4. Put the battery cover back in place.

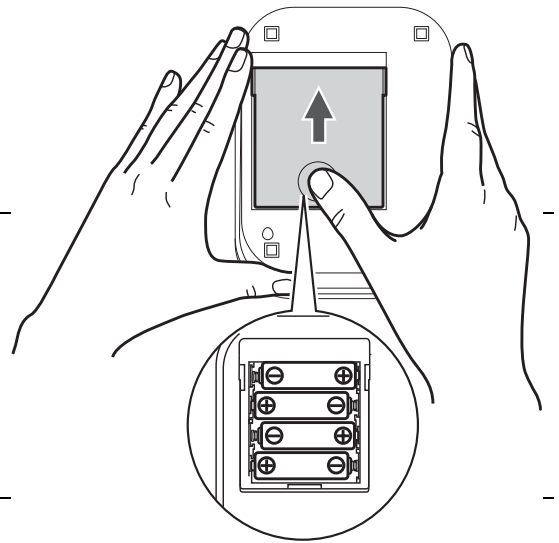

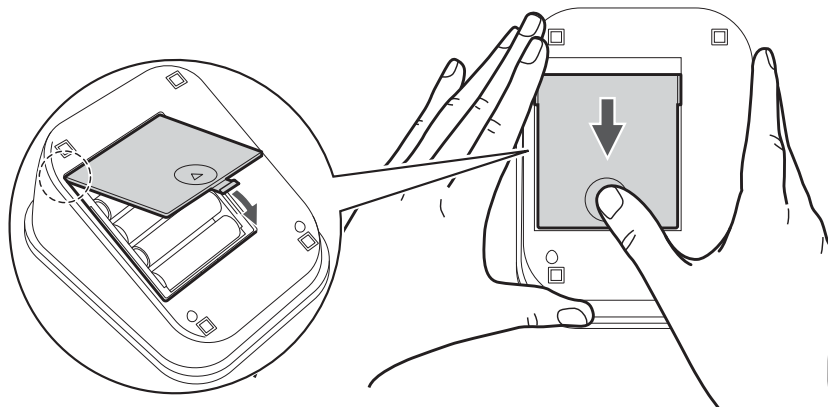

Slide the battery cover as indicated, until it clicks into place.



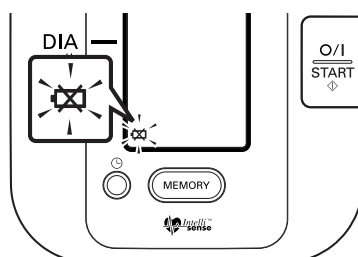

Note: The measurement values continue to be stored in memory even after the batteries are replaced.

Battery Life & Replacement



If the battery low symbol () appears on the display, replace all four batteries at the same time.

- When the battery low symbol () starts to blink, you will still be able to use the unit for a short while. You should replace the batteries with new ones ahead of time.
- When the symbol () remains lit, the batteries are exhausted. You should replace the batteries with new ones at once. Turn the unit off before replacing the batteries.
- Remove the batteries if the unit will not be used for three months or more.
- If the batteries have been removed for more than 30 seconds, the Date/Time setting will need to be reset. See “2.2 Setting the Date and Time” for details.
- Dispose of batteries according to applicable local regulations.

Four new “AA” alkaline batteries will last for approximately 1500 measurements, when used to take two measurements a day.

Since the supplied batteries are for monitoring use only, they may have a shorter life and not last for 1500 measurements.

2.2 Setting the Date and Time

Your blood pressure monitor automatically stores up to 42 measurements values in its memory and calculates an average value based on the three most recent measurements taken within 10 minutes of the last reading. (If there are only two readings in memory for that period, the average will be based on two readings. If there is only one reading in memory for that period, that reading will be displayed as the average value.) To make use of the memory and average values functions:

- Set the unit to the correct date and time before taking a measurement for the first time.
- If the batteries have been removed for more than 30 seconds, the Date/Time setting will need to be reset.

1. When the O/I START button is pressed to turn the unit on for the first time after inserting batteries, the year digits (2005) will flash on the display.

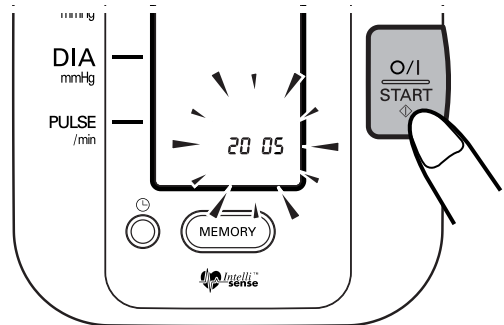

2. Press the MEMORY button to advance the digits one at a time.

Notes:

- The range for the year setting is 2005 to 2030. If the year reaches 2030, it will return to 2005.
- If you hold down the MEMORY button, the digits will advance rapidly.

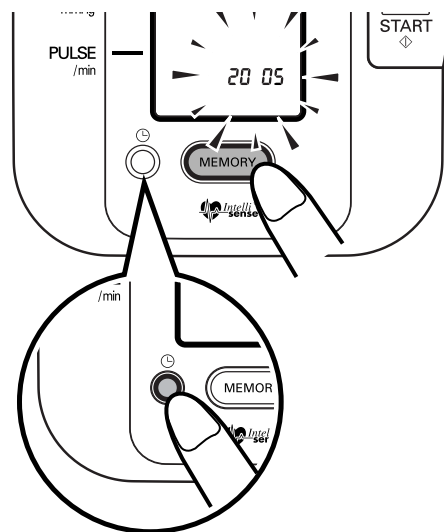

3. Press the SET button to confirm the setting when the desired number appears on the display.

The year is set and the month digits flash on the display.

4. Repeat steps 2 and 3 to set the month.

The month is set and the day digits flash on the display.

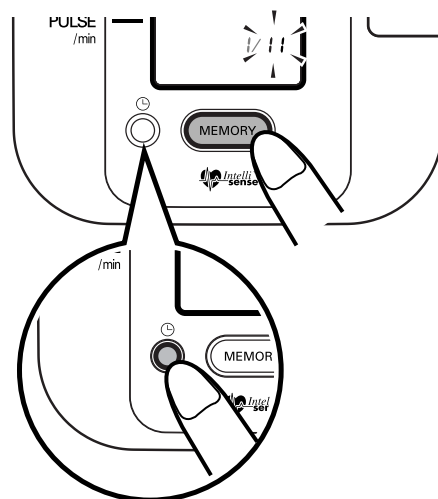

5. Repeat steps 2 and 3 to set the day.

The day is set and the hour digits flash on the display.

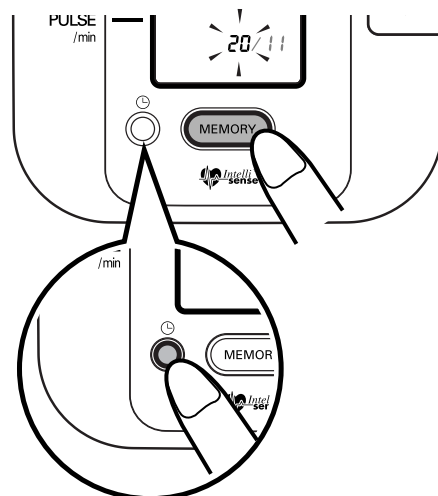

- 6.** Repeat steps 2 and 3 to set the hour.

The hour is set and the minutes digits flash on the display.

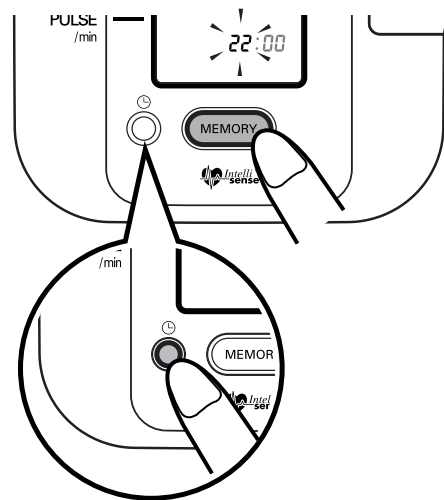

- 7.** Repeat steps 2 and 3 to set the minutes.

The minutes settings is set.

The unit automatically turns itself off after the minute setting has been set.

To adjust the date and time, press the Set button while the monitor is in standby mode.

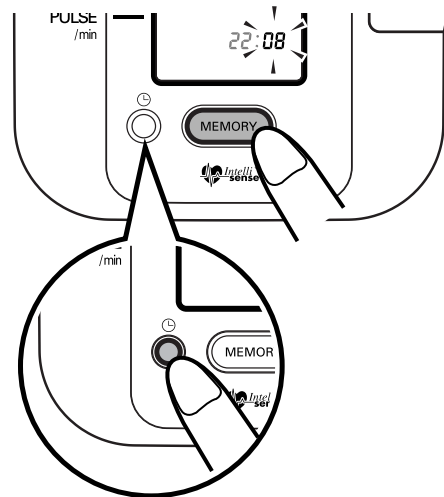

2.3 Adjusting the Settings Modes

You can modify the options for the various settings of your unit. This is done by pressing the SET button to select a setting, then pressing the MEMORY button to select the options for that setting. After selecting a setting, press the O/I START button to confirm the setting and turn the power off.

Buzzer Mode

When Buzzer mode is on, the unit emits sounds, during measurement, and when measurement is complete.

1. Press the SET button once while the unit is turned off.

The buzzer symbol appears on the display.

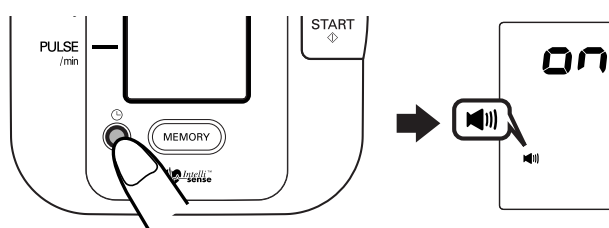

2. Press the MEMORY button to select "on" or "off".

The setting alternates between "on" and "off" with each press of the MEMORY button.

The default setting is "on".

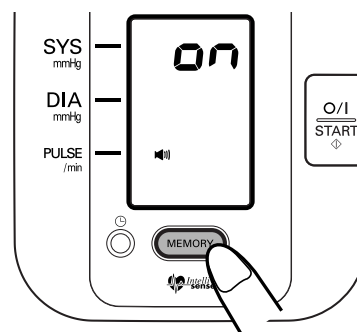

3. When you have selected the desired setting, press the O/I START button to turn the unit off.

Notes:

- If you want to adjust the date or time, press the SET button after setting the buzzer setting, follow steps for setting date and time (Refer to 2.2) press the O/I START button to turn the unit off.
- If you forget to turn the unit off, it will automatically shut itself off after five minutes.

3. Using the Unit

3.1 How to Sit Correctly When Taking a Measurement

You can take a measurement on either your left or right arm.

Notes:

- Measurements should be taken in a quiet place and you should be in a relaxed, seated position. Make sure that the room is not too hot or cold.
- Do not take measurement after bathing, drinking alcohol, or exercising.
- Do not move or talk during measurement.

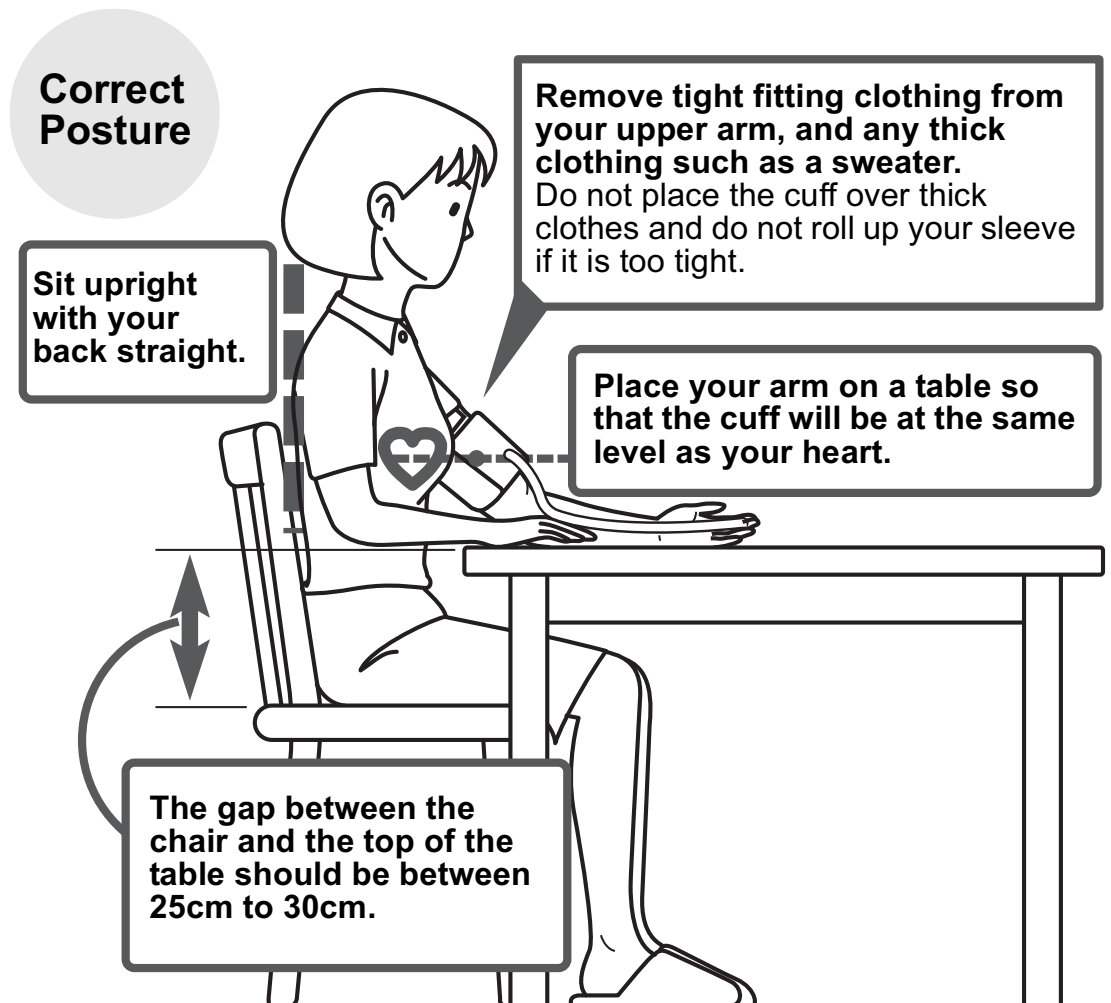

Notes:

- Correct posture during measurement is necessary to get accurate results.
- You should also try to measure your blood pressure at the same time each day. (Within 1 hour after waking up is recommended.)

Incorrect Posture

- **Arched back (leaning forwards)**
- **Sitting cross-legged**
- **Sitting on a sofa or at a low table so that you tend to lean forward**



These situations could lead to higher blood pressure values due to strain or the arm cuff being lower than the heart.

If the arm cuff is at a lower position than your heart use cushions etc., to adjust the height of your arm.

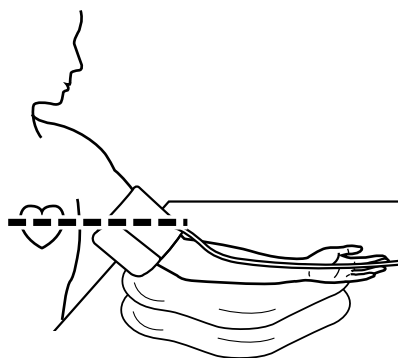

3.2 Applying the Arm Cuff

Be sure to wrap the arm cuff correctly so that you get accurate results.

Measurements can be taken in light clothing. However, please remove thick clothes, such as sweaters, before taking a reading.

1. Insert the air plug into the air jack on the left side of the main unit.

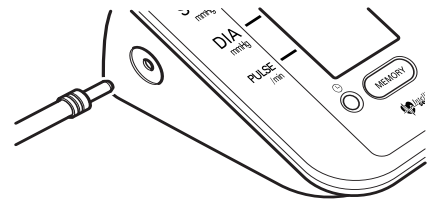

2. Put your left arm through the cuff loop.

The air tube should run down the inside of your forearm and be in line with your middle finger.

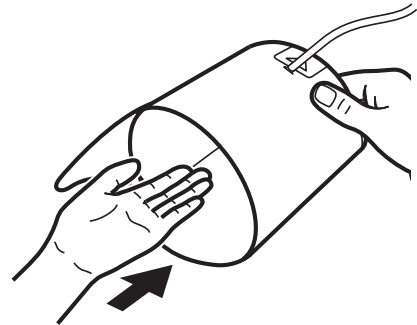

Note: If the cuff is not assembled, pass the end of the cuff furthest from the tubing through the metal D-ring to form a loop. The smooth cloth should be on the inside of the cuff loop.

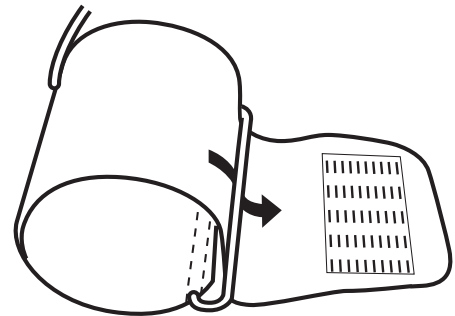

3. Position the arm correctly.

- 1) The air tube should run down the inside of your forearm and be in line with your middle finger.
- 2) The bottom of the cuff should be approximately 1 to 2 cm above your elbow.
- 3) Apply the cuff to your upper arm so that the coloured marker (blue arrow under tube) is centered on the middle of your inner arm and points down the inside of the arm.

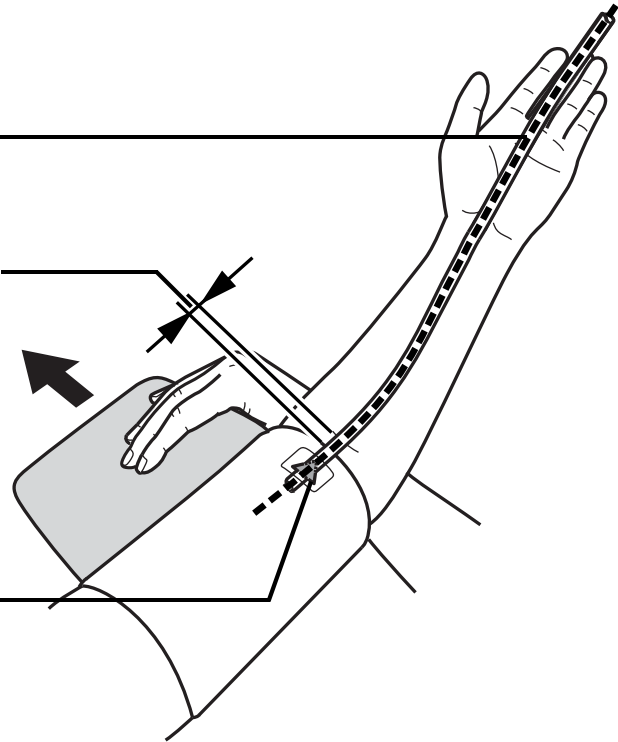

Taking measurements on the right arm

Apply the cuff so that the air tube is at the side of your elbow.

- Be careful not to rest your arm on the air tube, or otherwise restrict the flow of air to the cuff.
- The cuff should be 1 to 2 cm above the elbow.

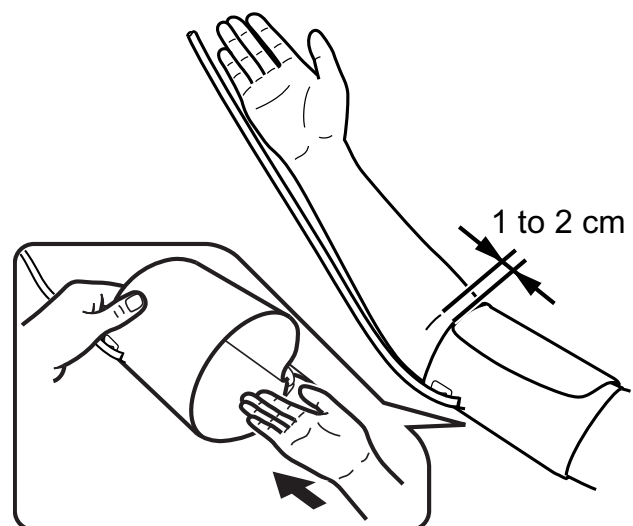

4. When the cuff is positioned correctly, close the fabric fastener **FIRMLY**.

3.3 Taking a Reading

1. Press the O/I START button to turn on the unit.

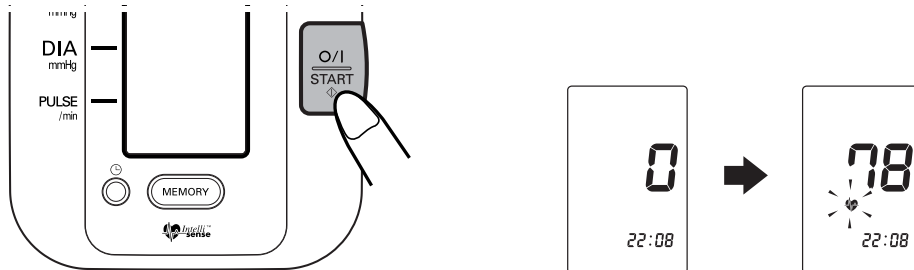

Sit in a chair with your feet flat on the floor and place your arm on a table so that the cuff will be at the same level as your heart. Keep still and do not talk during measurement.

During measurement, the buzzer (if set to “on”) will beep in rhythm with your heartbeat.

Note: To cancel a measurement, press the O/I START button to turn off the unit and to release the air in the arm cuff.

Common Causes of Inaccurate Results

Arm cuff is too loose.

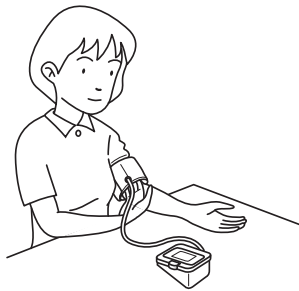

Movement or talking during measurement.



Leaning forwards.



Note: If the arm cuff is at a lower position than your heart use cushions etc., to adjust the height of your arm.

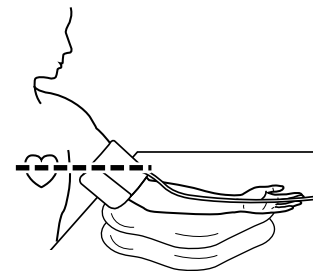

2. Check the measurement results.

The unit automatically stores blood pressure and pulse rate into its memory. Refer to “3.5 Using the Memory Function”.

The buzzer will sound when measurement is completed.

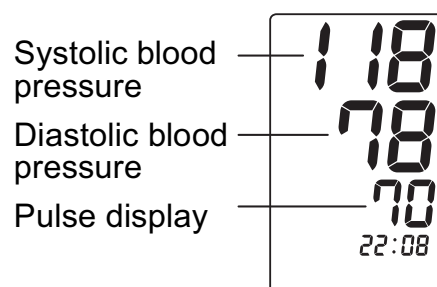
**Notes:**

- Self-diagnosis of measured results and treatment are dangerous. Please follow the instructions of your doctor.
- Wait 2-3 minutes before taking another blood pressure measurement. Waiting between readings allows the arteries to return to the condition prior to taking the blood pressure measurement.

Important:

- If your systolic or diastolic pressure is outside the standard range, the heartbeat symbol will blink when the measurement result is displayed.

Recent research suggests that the following values can be used as a guide to high blood pressure for measurements taken at home.



Systolic Blood Pressure	Above 135 mmHg
Diastolic Blood Pressure	Above 85 mmHg

This criteria is for home blood pressure measurement. For professional office blood pressure measurement criteria, please refer to Chapter 9 “Some Useful Information about Blood Pressure”.

- Your blood pressure monitor includes an irregular heartbeat feature. Irregular heartbeats can influence the results of the measurement. The irregular heartbeat algorithm automatically determines if the measurement is usable or needs to be repeated. If the measurement results are affected by irregular heartbeats but the result is valid, the result is shown together with the irregular heartbeat icon. If the irregular heartbeats cause the measurement to be invalid, no result is shown. If the irregular heartbeat icon () is shown after you have taken a measurement, repeat the measurement. If the irregular heartbeat icon is shown frequently, please make your doctor aware of it.

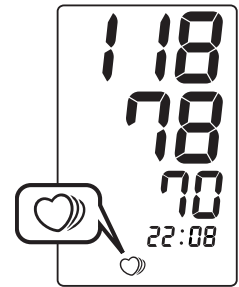

What is Irregular Heartbeat?

An irregular heartbeat is a heartbeat rhythm that varies by more than 25% from the average heartbeat rhythm detected while the unit is measuring the systolic and diastolic blood pressure.

If such an irregular rhythm is detected more than twice during measurement, the irregular heartbeat symbol () appears on the symbol when the measurement results are displayed.

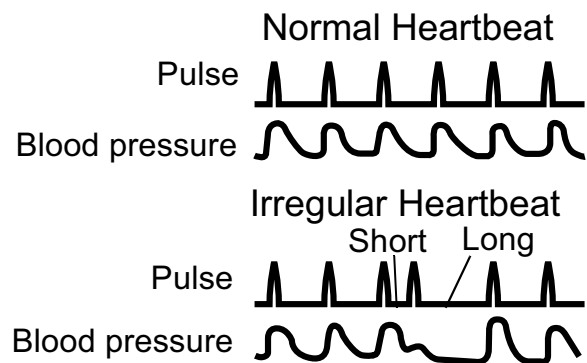

What is Arrhythmia?

A heartbeat is stimulated by electrical signals that cause the heart to contract.

Arrhythmia is a condition where the heartbeat rhythm is abnormal due to flaws in the bio-electrical system that drives the heartbeat. Typical symptoms are skipped heartbeats, premature contraction, an abnormally rapid (tachycardia) or slow (bradycardia) pulse. This can be caused by heart disease, aging, physical predisposition, stress, lack of sleep, fatigue etc. Arrhythmia can only be diagnosed by a doctor through a special examination.

Whether the appearance of the irregular heartbeat symbol () in the results indicates arrhythmia or not can only be determined by an examination and diagnosis by your doctor.

If the irregular heartbeat symbol () is shown frequently, please make your doctor aware of it. Conducting self-diagnosis and treatment based on measurement results is dangerous. Be sure to follow the instructions of your doctor.

3. Remove the arm cuff.
4. Press the O/I START button to turn the unit off.

Note: If you forget to turn the unit off, it will automatically shut itself off after five minutes.

3.4 Instructions for special conditions

If your systolic pressure is known to be more than 220 mmHg, press and hold the O/I START button until the arm cuff inflates 30 to 40 mmHg higher than your suspected systolic pressure.

1. Press the O/I START button to turn the unit on.
Measurement starts.

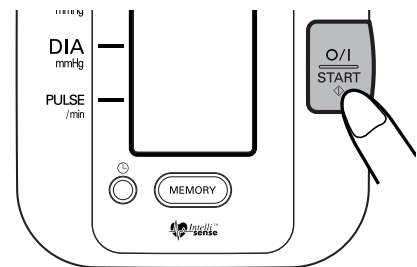

2. When the cuff starts to inflate, press the O/I START button and keep it pressed until the pressure is 30 to 40 mmHg higher than your suspected systolic pressure.

Note: You cannot inflate the cuff above 299 mmHg. (An error will be displayed if you try to inflate the cuff above 300 mmHg.)

3. Release the O/I START button when the cuff has been inflated to the desired pressure.
The cuff starts to deflate and measurement starts.
4. The rest of the procedure is the same as for normal measurement. Refer to 3.3, steps 2 to 4.

Note: Do not apply more pressure than necessary.

3.5 Using the Memory Function

This unit has a memory capable of storing 42 sets of readings. Every time you complete the measurement, the unit automatically stores the blood pressure and pulse rate.

If there are three readings within 10 minutes of the last reading, the average of the three readings is displayed. (If there are only two readings in memory for that period, the average will be based on two readings. If there is only one reading in memory for that period, that reading will be displayed as the average value.)

Note: When 42 sets of readings are stored in memory, the oldest set will be deleted to store a new set.

1. Press the MEMORY button.

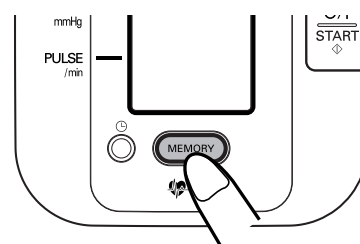

If there are three readings stored in memory that were taken within 10 minutes of the last reading, an average value for those reading is displayed. (If there are only two readings in memory for that period, the average will be based on two readings. If there is only one reading in memory for that period, that reading will be displayed as the average value.)

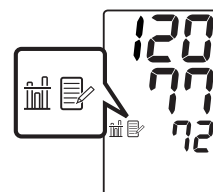

Note: If there are no measurements results stored in memory, the screen to the right is displayed.

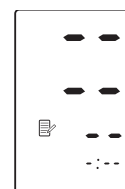

2. Press the MEMORY button again, while the average values screen is displayed.

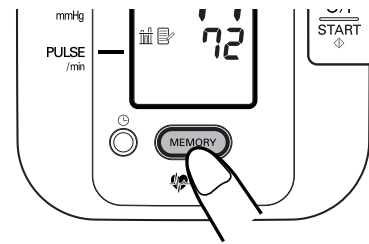

The result from the most recent measurement is displayed.

The date and time of each measurement is displayed alternately with the measurement values.

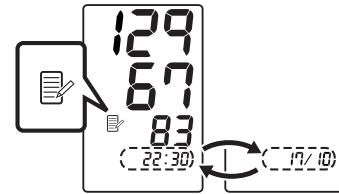

Important: If your systolic or diastolic pressure is outside the standard range, the heartbeat symbol will blink when the measurement result is displayed. Refer to 3.3, number 2.

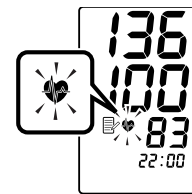

3. Press the MEMORY button repeatedly to cycle through the previous measurement results.

Keep the button pressed down to cycle rapidly through the previous results.

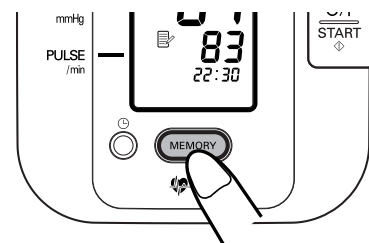

If the irregular heartbeat symbol was displayed at the time of a measurement, this is displayed when that result is displayed.

4. Press the O/I START button to turn the unit off.

If you forget to turn the unit off, it will automatically shut itself off after five minutes.

To Delete All the Values Stored in Memory

You cannot delete individual stored readings, all the readings in the unit will be deleted.

1. To delete stored readings, first press the MEMORY button. Then while holding it down, press the O/I START button simultaneously for about 2-3 seconds. All readings will then be deleted.

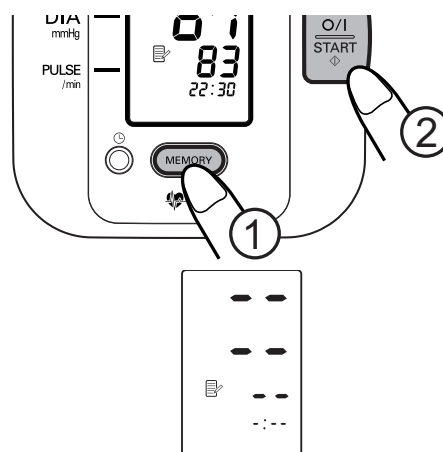

Important: Be careful not to press the O/I START button first. If the O/I START button is pressed first, measurement will start.

2. Press the O/I START button to turn the unit off.

If you forget to turn the unit off, it will automatically shut itself off after five minutes.

Note: If the date and time are reset to a time before the most recent measurement, the average value will be based on any measurements taken after the date and time were reset. However, you can still view the readings stored in memory.

4. Quick Reference Guide

If you are using this device for the first time, please read carefully chapter 3 of this instruction manual. To help ensure a reliable reading, avoid eating, smoking, or exercising for at least 30 minutes before taking a measurement.

Note: Remove any tight-fitting clothing from your upper arm.

1. Sit on a chair with your feet flat on the floor and place your arm on a table so that the arm cuff will be at the same level as your heart.

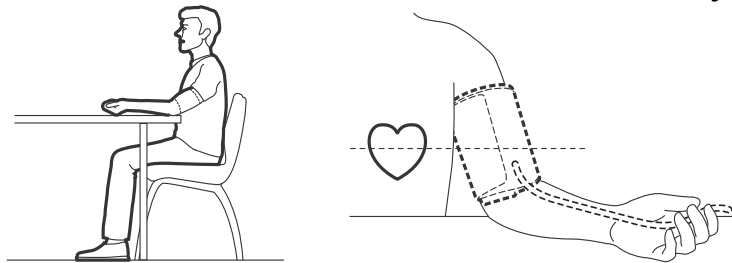

2. Apply the arm cuff to your upper arm. The coloured marker should be centred on the inside of your arm and point down the inside of the arm, so that the air tube runs down the inside of your forearm and is in line with your middle finger.

3. Secure the cuff around your arm using the fabric fastener strip.

4. Press the O/I START button.

When measurement is complete, the monitor displays your blood pressure and pulse rate, and automatically deflates the cuff.

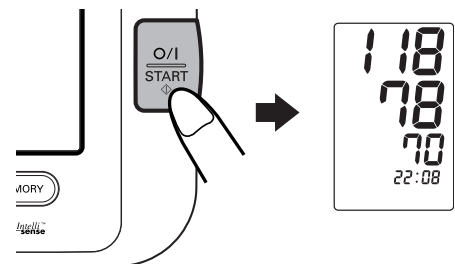



Notes:

- Always wait at least 2-3 minutes before taking another blood pressure measurement.
- Please note that all measurements are stored in the memory. If different people measure with the same device make sure that you are aware of this fact.

5. Handling Errors and Problems

5.1 Error Messages

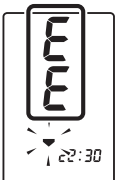
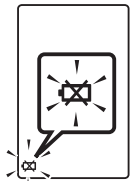
Error Display	Cause	Remedy
	Cuff is under inflated.	Carefully read and repeat the steps listed under section 3.4.
	Movement during measurement	Repeat measurement. Remain still and do not talk during measurement. Refer to section 3.3.
	Air plug disconnected.	Insert the air plug securely. Refer to section 3.2.
	Arm cuff not applied correctly.	Apply the arm cuff correctly. Refer to section 3.2.
	Clothing is interfering with the arm cuff.	Remove any clothing interfering with the arm cuff. Refer to section 3.2.
	Air is leaking from the arm cuff.	Replace cuff with new one. Refer to Chapter 7.
	The arm cuff was inflated above 299 mmHg when inflating the cuff manually.	Release your finger from the O/I START button before the pressure reaches 299 mmHg, when inflating the cuff manually. Refer to section 3.4.
 <p>Blinks or appears continuously</p>	Battery power is low.	Replace all four "AA" batteries with new ones. Refer to section 2.1.

5. Handling Errors and Problems

Error Display	Cause	Remedy
	Device error.	Contact your OMRON retail outlet or distributor. Refer to Chapter 8.

Note: The irregular heartbeat symbol may also be displayed with error messages.

5.2 Troubleshooting

Problem	Cause	Remedy
The reading is extremely low (or high).	Arm cuff not applied correctly.	Apply the arm cuff correctly. Refer to section 3.2.
	Movement or talking during measurement.	Remain still and do not talk during measurement. Refer to section 3.3.
	Clothing is interfering with the arm cuff.	Remove any clothing interfering with the arm cuff. Refer to section 3.1.
Arm cuff pressure does not rise.	Is the air jack securely inserted into the main unit?	Make sure that the air jack is connected securely. Refer to section 3.2.
	Air is leaking from the arm cuff.	Replace the arm cuff with a new one. Refer to Chapter 7.
Arm cuff deflates too soon.	The arm cuff is loose.	Apply the cuff correctly so that it is firmly wrapped around the arm. Refer to section 3.2.
Cannot measure or readings are too low or too high.	Has the arm cuff been inflated sufficiently?	Inflate the cuff so that it is 30 to 40 mmHg above your previous measurement result. Refer to section 3.4.
The unit loses power during measurement.	The batteries are empty.	Replace the batteries with new ones.
Nothing happens when you press the buttons.	The batteries are empty.	Replace the batteries with new ones.
	The batteries have been inserted incorrectly.	Insert the batteries with the correct (+/-) polarity.

5. Handling Errors and Problems

Problem	Cause	Remedy
Other problems.	Press the O/I START button and repeat measurement. If the problem continues, try replacing the batteries with new ones. If this still does not solve the problem, contact your OMRON retail outlet or distributor.	

6. Maintenance and Storage

Maintenance

To protect your unit from damage, please observe the following:

- Do not subject the main unit and cuff to extreme temperatures, humidity, moisture or direct sunlight.
- Do not fold the cuff or tubing tightly.
- Do not inflate the arm cuff over 299 mmHg.
- Do not disassemble the unit.
- Do not subject the unit to strong shocks or vibrations (for example, dropping the unit on the floor).
- Do not use volatile liquids to clean the main unit. The unit should be cleaned with a soft, dry cloth.
- Do not wash the arm cuff or immerse it in water.
- Do not use petrol, thinners or similar solvents to clean the arm cuff.

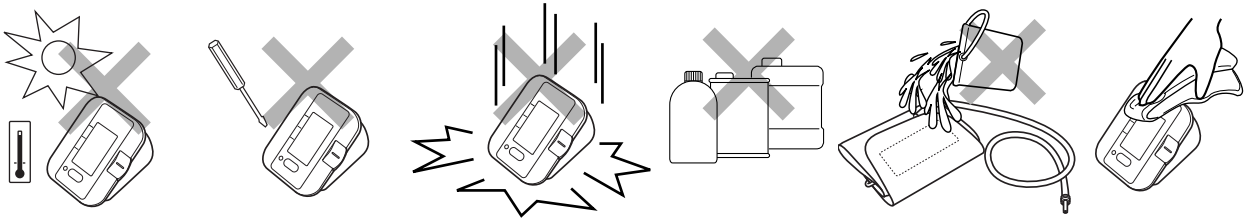

- Use a soft, moistened cloth and soap to clean the arm cuff.
- Do not carry out repairs of any kind by yourself. If a defect occurs, consult your OMRON retail outlet or distributor as mentioned on the packaging.

Calibration and Service

- The accuracy of this blood pressure monitor has been carefully tested and is designed for a long service life.
- It is generally recommended to have the unit inspected every two years to ensure correct functioning and accuracy. Please consult your authorised OMRON dealer or the OMRON Customer Service at the address given on the packaging or attached literature.
- Do not carry out any repairs yourself. If a defect occurs or you have doubts about the correct functioning of the device, consult your authorised OMRON dealer or the OMRON Customer Service.

Storage

Keep the unit in its storage case when not in use.

1. Unplug the air tube from the air jack.

2. Gently fold the air tube into the arm cuff.

Note: Do not bend the air tube excessively.

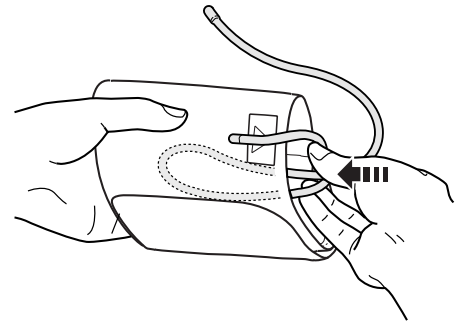

3. Place the arm cuff and main unit in the storage case.

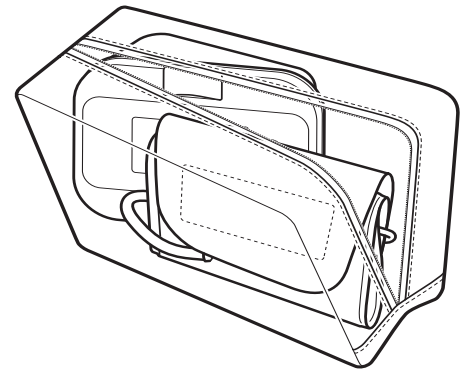

Do not store the unit in the following situations:

- If the unit is wet.
- Locations exposed to extreme temperatures, humidity, direct sunlight, dust or corrosive vapours.
- Locations exposed to vibrations, shocks or where it will be at an angle.
- Locations exposed to chemicals or corrosive vapours.

7. Optional Parts

Medium Arm Cuffs

Arm circumference 22 - 32 cm

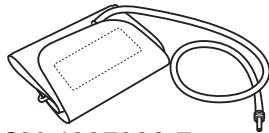

CM-4997086-7

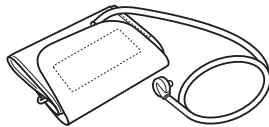

CM1-7935058-8

Large Arm Cuff

Arm circumference 32 - 42 cm

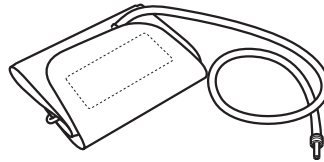

CL-4997065-4

AC Adapter "Q"

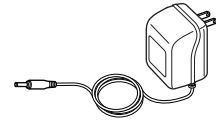

Q Adapter-1098336-8

Using the Optional AC Adapter

Insert batteries into the battery compartment even when using the AC adapter.

Notes:

- Never unplug the power cord with wet hands.
- Use only the original AC adapter designed for this unit. Use of unsupported adapters may damage the unit.
- When storing the optional AC adapter with the main unit, be careful not to damage the main unit or cuff.

1. Insert the AC adapter plug into the AC adapter jack on the rear side of the main unit.
2. Plug the AC adapter into an electrical outlet.

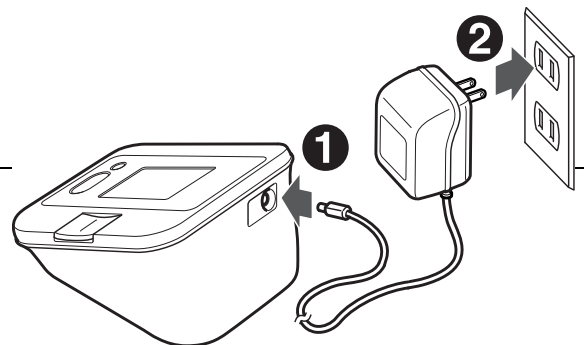

To disconnect the AC adapter, unplug the AC adapter from the electrical outlet first and then immediately remove the AC adapter plug from the main unit.

8. Technical Data

Product Description	Digital Automatic Blood Pressure Monitor
Model	OMRON M3 Intellisense (HEM-7051-E)
Display	LCD Digital Display
Measurement Method	Oscillometric method
Measurement Range	Pressure: 0 mmHg to 299 mmHg Pulse: 40 to 180/min.
Memory	42 Measurements with date and time
Accuracy	Pressure: ± 3 mmHg Pulse: $\pm 5\%$ of display reading
Inflation	Fuzzy-logic controlled by electric pump
Deflation	Automatic pressure release valve
Pressure Detection	Capacitive pressure sensor
Power Source	4 "AA" batteries 1.5V or AC/ DC adapter (optional, 6V = 4W)
Battery life	Capacity of new alkaline batteries is approx. 1500 measurements
Operating temperature/ Humidity	+10°C to +40°C Maximum: 30 to 85% RH
Storage temperature Humidity	-20°C to +60°C Maximum: 10 to 95% RH
Console Weight	Approximately 340g without batteries
Cuff Weight	Approximately 130g
Outer Dimensions	Approximately 121 (w) mm \times 86 (h) mm \times 141(l) mm
Cuff Dimensions	Approximately 146 mm \times 446 mm (Medium cuff: arm circumference 22 to 32 cm)
Package Content	Medium cuff, instruction manual, storage case, battery set, guarantee card, blood pressure pass

EN

Note: Subject to technical modification without prior notice

- This OMRON product is produced under the strict quality system of OMRON Healthcare Co. Ltd., Japan. The Core component for OMRON blood pressure monitors, which is the Pressure Sensor, is produced in Japan for assembly.
- Disposal of this product and used batteries should be carried out in accordance with the national regulations for the disposal of electronic products.



= Type B

CE 0197



This device fulfils the provisions of EC directive 93/42/EEC (Medical Device Directive). This blood pressure monitor is designed according to the European Standard EN1060, Non-invasive sphygmomanometers Part 1: General Requirements and Part 3: Supplementary requirements for electromechanical blood pressure measuring systems.



Caution: Please read the instruction manual carefully before using the device.

Important information regarding Electro Magnetic Compatibility (EMC)

With the increased number of electronic devices such as PC's and mobile (cellular) telephones, medical devices in use may be susceptible to electromagnetic interference from other devices. Electromagnetic interference may result in incorrect operation of the medical device and create a potentially unsafe situation. Medical devices should also not interfere with other devices.

In order to regulate the requirements for EMC (Electro Magnetic Compatibility) with the aim to prevent unsafe product situations, the EN60601-1-2 standard has been implemented. This standard defines the levels of immunity to electromagnetic interferences as well as maximum levels of electromagnetic emissions for medical devices.

This medical device manufactured by OMRON Healthcare conforms to this EN60601-1-2:2001 standard for both immunity and emissions.

Nevertheless, special precautions need to be observed:

- Do not use mobile (cellular) telephones and other devices, which generate strong electrical or electromagnetic fields, near the medical device. This may result in incorrect operation of the unit and create a potentially unsafe situation. Recommendation is to keep a minimum distance of 7 m. Verify correct operation of the device in case the distance is shorter.

Further documentation in accordance with EN60601-1-2:2001 is available at OMRON Healthcare Europe at the address mentioned in this instruction manual. Documentation is also available at www.omron-healthcare.com.



**Correct Disposal of This Product
(Waste Electrical & Electronic Equipment)**

This marking shown on the product or its literature, indicates that it should not be disposed of, with other household wastes at the end of its working life. To prevent possible harm to the environment or human health from uncontrolled waste disposal, please separate this from other types of wastes and recycle it responsibly to promote the sustainable reuse of material resources.

Household users should contact either the retailer where they purchased this product, or their local government office, for details of where and how they can take this item for environmentally safe recycling.

Business users should contact their supplier and check the terms and conditions of the purchase contract. This product should not be mixed with other commercial wastes for disposal.

This product does not contain any hazardous substances.

9. Some Useful Information about Blood Pressure

What is Blood Pressure?

Blood pressure is a measure of the force of blood flowing against the walls of the arteries. Arterial blood pressure is constantly changing during the course of the heart's cycle.

The highest pressure in the cycle is called the *Systolic Blood Pressure*; the lowest is the *Diastolic Blood Pressure*.

Both pressure readings, the *Systolic* and *Diastolic*, are necessary to enable a doctor to evaluate the status of a patient's blood pressure.

Why is it a Good Thing to measure Blood Pressure at Home?

Having your blood pressure measured by a doctor can cause anxiety which is itself a cause of high blood pressure. As a variety of conditions affect blood pressure, a single measurement may not be sufficient for an accurate diagnosis.

Many factors such as physical activity, anxiety, or the time of day, can influence your blood pressure. Thus it is best to try and measure your blood pressure at the same time each day, to get an accurate indication of any changes in blood pressure. Blood pressure is typically low in the morning and increases from afternoon to evening. It is lower in the summer and higher in the winter.

Blood pressure is measured in millimetres of mercury (mmHg) and measurements are written with the systolic pressure before the diastolic e.g. A blood pressure written as 135/85, is referred to as 135 over 85 mmHg.

9. Some Useful Information about Blood Pressure

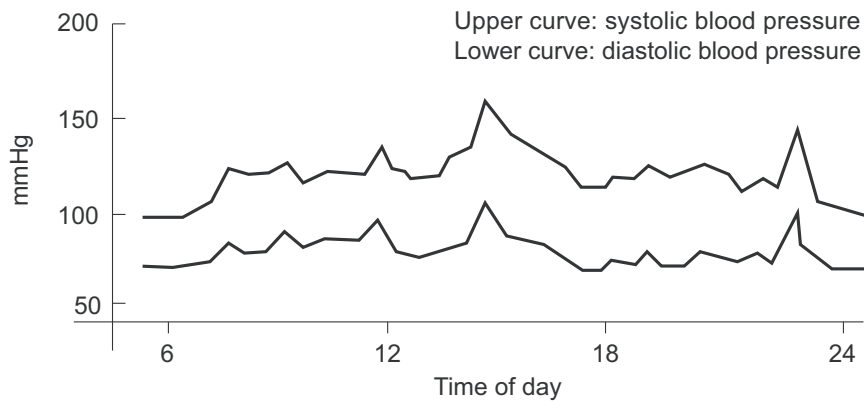

Example: fluctuation within a day (male, 35 years old)

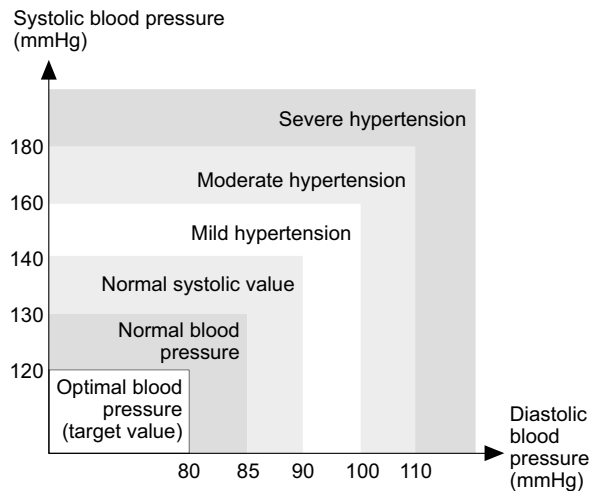

Classification of Blood Pressure by the World Health Organization

The World Health Organization (WHO) and the International Society of Hypertension (ISH) developed the Blood Pressure Classification shown in this figure.



This classification is based on the blood pressure values measured on people in a sitting position in outpatient departments of hospitals.

* There is no universally accepted definition of hypotension. However, those having the systolic pressure below 100 mmHg are assumed as hypotensive.

Manufacturer	OMRON HEALTHCARE CO., LTD. 24, Yamanouchi Yamanoshita-cho, Ukyo-ku, Kyoto, 615-0084, Japan 
EU-representative	OMRON HEALTHCARE EUROPE B.V. Kruisweg 577, 2132 NA Hoofddorp, The Netherlands www.omron-healthcare.com 
Production facility	OMRON DALIAN CO., LTD. Economic & Technical Development Zone Dalian 116600, China
Subsidiary	OMRON HEALTHCARE UK LTD. Opal Drive Fox Milne, Milton Keynes MK15 0DG, United Kingdom
	OMRON Medizintechnik Handelsgesellschaft mbH John-Deere-Str. 81a, 68163 Mannheim, Germany www.omron-medizintechnik.de
	OMRON SANTÉ FRANCE SAS 14, rue de Lisbonne, 93561 Rosny-sous-Bois Cedex, France

Made in China

9. Some Useful Information about Blood Pressure
